

Blue-Bay Plus

LED - High Performance High/Low Bay with Bluetooth Configurable Occupancy and Daylight Harvesting Sensor

Project:	Catalogue #:	Type:
Notes:		

Product Description

The Blue-Bay Plus is a standard-efficacy luminaire available in a wide range of lumen packages and configurations. It features a smart passive infrared (PIR) integrated sensor with advanced optics to provide an exceptional field of view for mounting heights from 8-40 ft. With an operating ambient temperature range as low as -30°C to as high as 55°C on most models and up to 168 lm/W, the Blue-Bay provides the versatility required for a wide range of demanding high and low bay applications.

Applications

Manufacturing areas, Retail stores and supermarkets, Warehouse and distribution (not for freezers and areas of high humidity or condensation).

Features

- Configurations exceeding 168 lm/W
- As low as -30°C to as high as 55°C ambient temperature on most models (see delivered lumens tables)
- Standard low voltage dimming (0-10v)
- Ideal for installations requiring daylight harvesting
- PIR detection technology with advanced optics
- Easy Bluetooth programming and configuration
- Adjust sensor sensitivity to increase or decrease coverage area
- Configurable daylight modes

Featured Options

- Adjustable cable suspension
- Emergency lighting battery pack
- Narrow Distribution Optic
- Lensing

Mounting

This luminaire is specifically designed for suspended mount applications, including stem, chain & adjustable aircraft cable. Mounting kits available (ordered separately).

Construction

CNC fabricated, code gauge steel housing and ends, with integral ventilation slots and heat sinks.

Finish

White, pre-painted housing.

Electrical

CSA/UL approved electronic components. Long life LEDs coupled with high efficiency drivers, provide quality illumination. Rated to deliver L80 performance for 50,000 hours at 40°C ambient temperature.

Control

Bluetooth low energy (BLE) enabled for sensor configuration through the Leviton Smart Sensor App. Advance optics included for 8-20ft low-mid bay and 20-40ft mid-high bay applications. Optional aisle-way masks are also included for both lenses. Programmable step dimming occupancy level (5-100%). Out-of-the box configuration features Auto-ON/Auto-OFF with 20-minute timeout, sensitivity set to high, and daylight harvesting enabled with auto calibration.

Warranty

5 year limited warranty. For complete warranty, click here: 

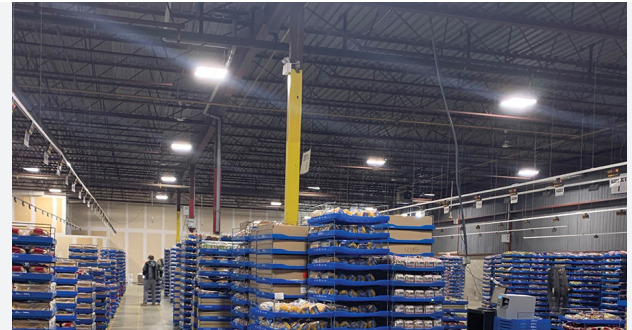

Approvals

- Approved to CSA and UL standards
- Tested in accordance to IESNA LM-79.
- Suitable for damp locations.
- DesignLights Consortium® Qualified.
- DesignLights Consortium® Premium Qualified.
- Complies with IECC, ASHRAE 90.1, and 2019 Title 24, Part 6 occupancy/vacancy sensing and dimming requirements.

All configurations may not be DLC qualified. Check www.designlights.org/QPL for qualified configurations.

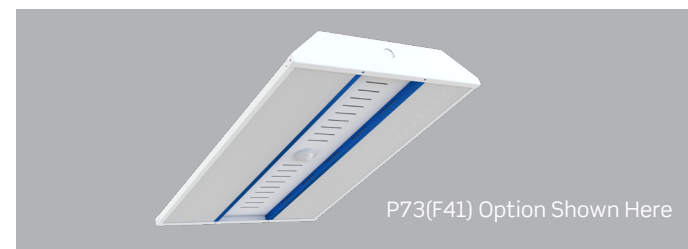

Dimensions

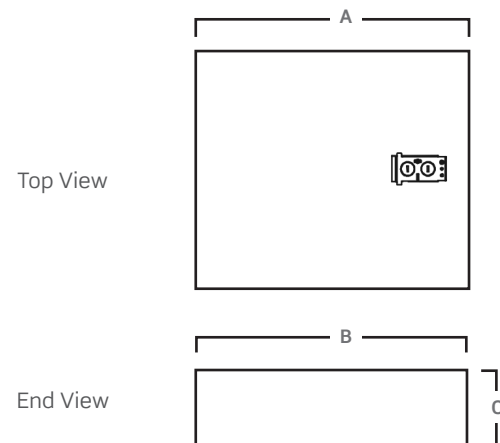

Size	A	B	C
224	24"	16"	3"
248	48"	16"	3"
424	24"	24"	3"
448	48"	24"	3"

Consult installation guide for exact dimensions.

Project:	Catalogue #:	Type:
Notes:		

Order Key

EXAMPLE: : LHBC248-LED840K240LUNV

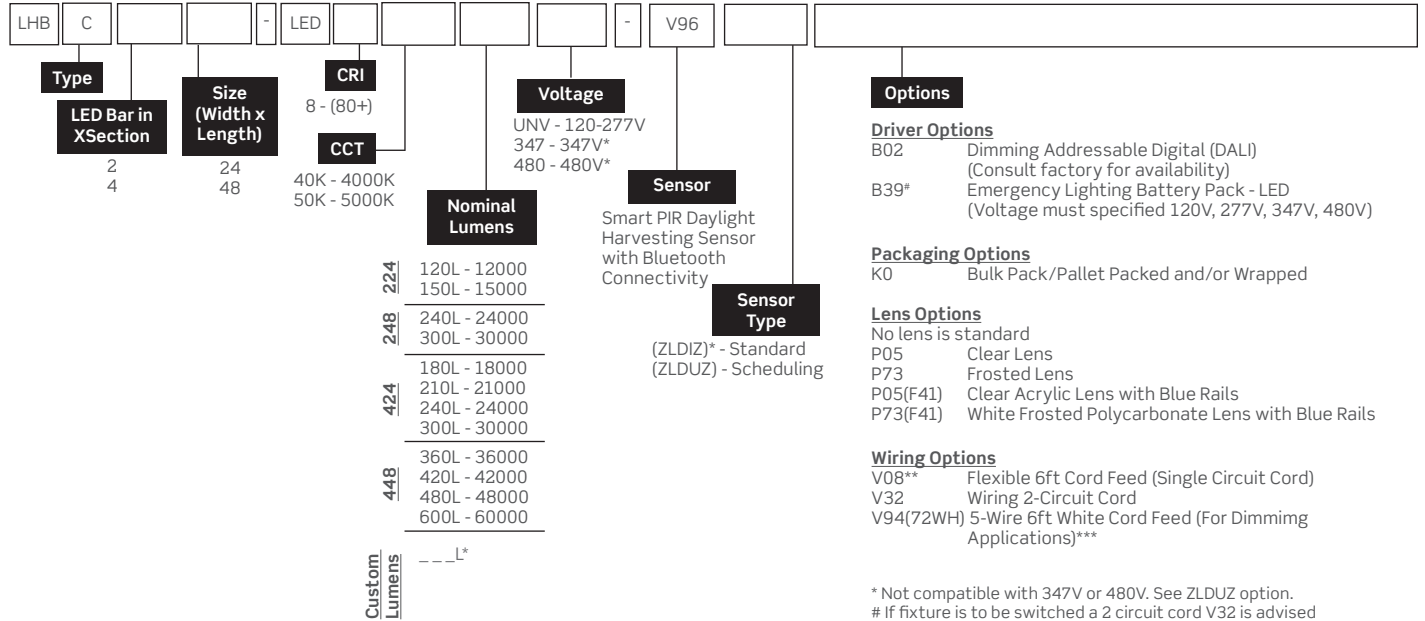

* Not compatible with 347V or 480V. See ZLDUZ option.
If fixture is to be switched a 2 circuit cord V32 is advised

** For pendant mounted applications only, not for use in surface mount applications.

***Other finishes and cord lengths may be available, consult factory.

Other options may be available, consult factory. Specifications and data subject to change without notice.

*Custom Lumens		
Size	Nominal Lumens Range	Watts
224	6000 - 18000	43 - 126
248	12000 - 35000	83 - 280
424	12000 - 32000	95 - 203
448	24000 - 60000	165 - 412

*28000Lm Example:
LHBC424-LED840K280LUNV-V96(ZLDIZ)

Mounted Accessories (Ordered Separately)	
KIT00002	Speedy Hangers
KIT00003	Mounting Stems & Canopy Set 3/8"IP (2) 4ft.
KIT00004	Aircraft "Y" Cable (10ft) with Adjustable Grip (2)
KIT00016	Deck Plate Ribbed Square
KIT00021	Speedy Hangers with 48-in. Chain Set (2)
KIT00062-(3/4)	Mounting for 3/4-in. Threaded pipe (Stem not Included)
KIT00062-(1/2)	Mounting for 1/2-in. Threaded pipe (Stem not Included)
KIT00062-(3/8)	Mounting for 3/8-in. Threaded pipe (Stem not Included)

Performance Scaling Factor

	50K	40K	35K	30K
80CRI	1.000	1.000	0.960	0.946
90CRI	0.875	0.875	0.836	0.809

Lens & Frame Accessories (If needed to be ordered separately)				
	224	248	424	448
P05 - Clear Lens	KIT00032	KIT00033	KIT00099	KIT00100
P73 - Frosted Lens	KIT00036	KIT00037	KIT00130	KIT00129

Project:	Catalogue #:	Type:
Notes:		

Performance Data



LED Performance Data									
Size	Nominal Lumens	Delivered Lumens 4000K 80CRI*						Watts	Ambient Rating (°C)
		No Lens	No Lens lm/W	P73 Lens	P73 Lens lm/W	P05 Lens	P05 Lens lm/W		
224	120L	12280	165	10562	142	11521	155	74	55
	150L	15661	160	13491	137	14778	151	98	53

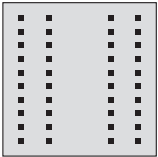

LED Performance Data									
Size	Nominal Lumens	Delivered Lumens 4000K 80CRI*						Watts	Ambient Rating (°C)
		No Lens	No Lens lm/W	P73 Lens	P73 Lens lm/W	P05 Lens	P05 Lens lm/W		
424	180L	18504	158	16051	137	17358	148	117	55
	210L	21671	156	18782	135	20244	147	139	55
	240L	24677	165	21417	143	23051	154	150	55
	300L	32644	160	27256	134	29387	144	204	55

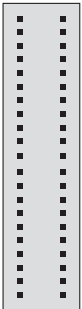

LED Performance Data									
Size	Nominal Lumens	Delivered Lumens 4000K 80CRI*						Watts	Ambient Rating (°C)
		No Lens	No Lens lm/W	P73 Lens	P73 Lens lm/W	P05 Lens	P05 Lens lm/W		
248	240L	24814	165	21386	143	23157	154	150	55
	300L	31614	157	27173	135	29392	145	202	55



LED Performance Data									
Size	Nominal Lumens	Delivered Lumens 4000K 80CRI*						Watts	Ambient Rating (°C)
		No Lens	No Lens lm/W	P73 Lens	P73 Lens lm/W	P05 Lens	P05 Lens lm/W		
448	360L	37581	161	32391	138	35093	150	234	55
	420L	43991	158	37539	135	40786	147	278	55
	480L	49992	160	43159	138	46653	150	312	55
	600L	63722	155	54962	134	59490	145	411	55

* Lumens/Watt and wattage is based on 25°C

Project:	Catalogue #:	Type:
Notes:		

Photometrics

IES File: **LHBC424-LED840K180LUNV**
 Lumens: **17965**
 Wattage: **118.2**
 Efficacy: **152**

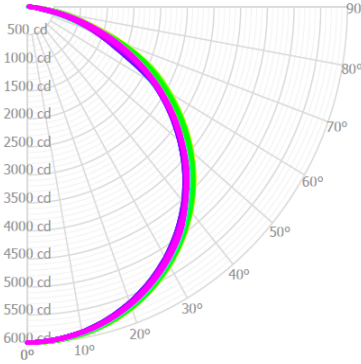

Zonal Lumen Summary

Zone	Lumens	%Fixture
0.0° - 30.0°	4739	26.4%
0.0° - 40.0°	7854	43.7%
0.0° - 60.0°	14170	78.9%
0.0° - 90.0°	17704	98.6%

Average Luminance Table (cd/m²) CP Summary

	0.00°	45.00°	90.00°
0.00°	16463	16463	16463
45.00°	16557	17105	17165
55.00°	16072	16870	17089
65.00°	14933	16010	16512
75.00°	11944	12792	12579
85.00°	4481	6934	5121

Coefficients of Utilization

pc	80%			70%			50%		
	70%	50%	30%	70%	50%	30%	70%	50%	30%
0	119	119	119	116	116	116	110	110	110
1	109	104	100	106	102	98	101	97	94
2	99	91	84	96	89	82	91	85	80
3	90	80	71	87	78	70	83	75	68
4	82	70	62	80	69	61	75	66	59
5	76	63	54	73	62	53	69	59	52
6	70	56	47	68	55	47	64	53	46
7	65	51	42	63	50	42	59	48	41
8	60	46	38	58	46	38	55	44	37
9	56	43	34	55	42	34	52	41	33
10	53	39	31	51	39	31	49	38	31

Effective Floor Cavity Reflectance: 20%

IES File: **LHBC448-LED840K360LUNV**
 Lumens: **36486**
 Wattage: **234**
 Efficacy: **156**

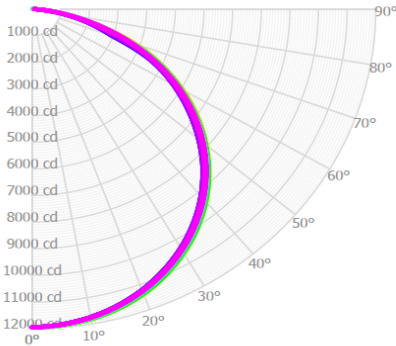

Zonal Lumen Summary

Zone	Lumens	%Fixture
0.0° - 30.0°	9448	25.9%
0.0° - 40.0°	15671	43.0%
0.0° - 60.0°	28463	78.0%
0.0° - 90.0°	36027	98.7%

Average Luminance Table (cd/m²) CP Summary

	0.00°	45.00°	90.00°
0.00°	16239	16239	16239
45.00°	16607	16812	16788
55.00°	16466	16757	16601
65.00°	15643	16110	15741
75.00°	12976	12501	11277
85.00°	5738	4942	3492

Coefficients of Utilization

pc	80%			70%			50%		
	70%	50%	30%	70%	50%	30%	70%	50%	30%
0	119	119	119	116	116	116	110	110	110
1	109	104	100	106	101	98	100	97	94
2	99	90	83	96	88	82	91	85	79
3	90	79	71	87	77	70	82	74	68
4	82	70	61	80	68	60	75	66	59
5	75	62	53	73	61	53	69	59	51
6	69	56	47	67	55	46	64	53	45
7	64	51	42	62	50	41	59	48	40
8	60	46	37	58	45	37	55	44	36
9	56	42	34	54	42	34	52	40	33
10	52	39	31	51	38	31	48	37	30

Effective Floor Cavity Reflectance: 20%

Project:	Catalogue #:	Type:
Notes:		

Field of View Diagrams - Low Bay Sensor Lens

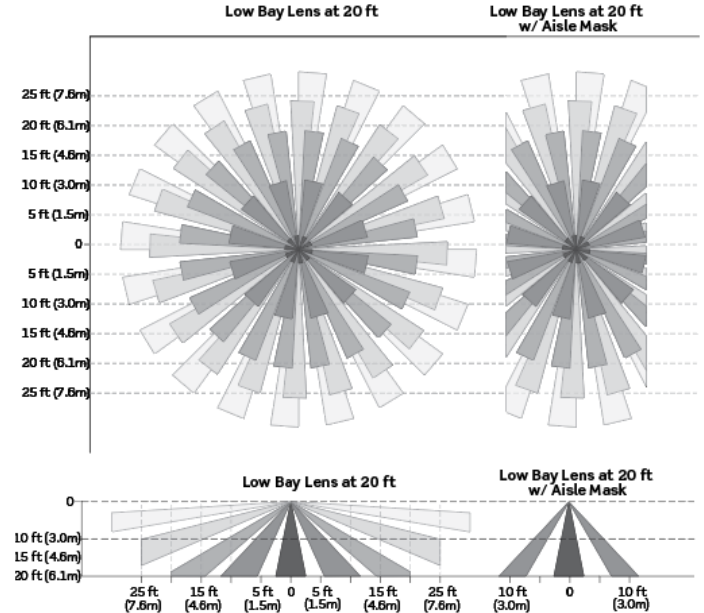
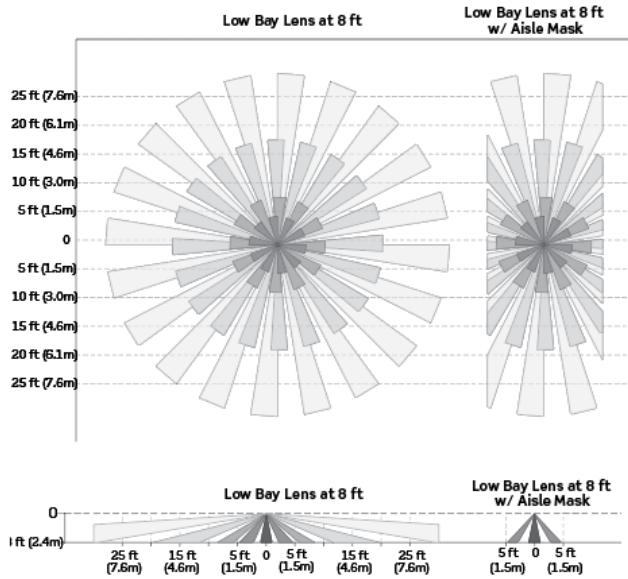

Field of View Diagrams - High Bay Sensor Lens

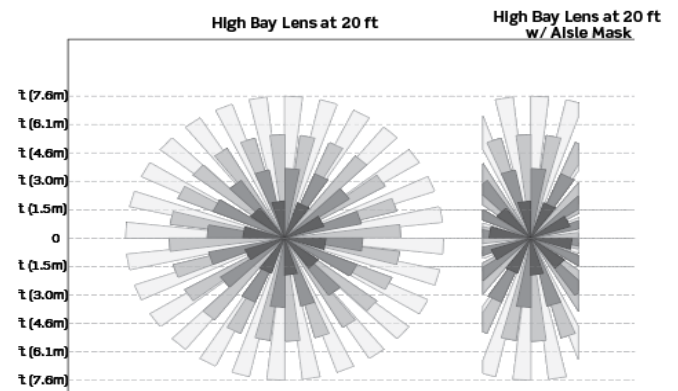
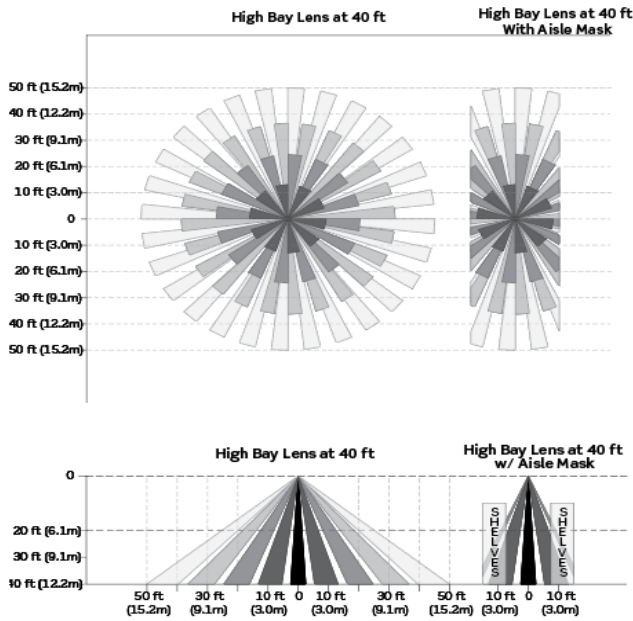

Mounting Height (Ft.)	Field of View Lens	Major (Sq.Ft.)	Minor (Sq. Ft.)
8	Low Bay	2050	900
15	Low Bay	1750	750
20	Low Bay	1850	350
20	High Bay	2300	1050
30	High Bay	5300	800
40	High Bay	8250	550