

# Allura A Extended

LED - Linear Pendant A - Architectural Lighting

Project:	Catalogue #:	Type:
Notes:		

## Product Description

Premium-grade, pendant-mount, bi-directional luminaire. The Allura features an architectural slim profile with soft curves to enhance the visual space, and is available with row-mounting capability. This pendant-mount luminaire comes with a double tear drop shaped frosted diffuser that offers a high level of efficiency and visual comfort.

## Applications

Boardrooms, Corridors, Retail Stores and Supermarkets, Studio Lofts, Offices

## Features

- Double teardrop extruded diffusers
- Standard low voltage dimming (0-10v, 1%)
- Suitable for row-mounting

## Featured Options

- Aircraft cable power feed suspension kit
- Emergency lighting battery pack

## Optical System

Frosted acrylic diffuser offer high levels of efficiency and visual comfort. The bi-directional optics provide a wide, uniform light distribution. Standard distribution is 50% up and 50% down.

## Mounting

Single-point aircraft cable mounting system used at each hanging location.

## Construction

Precision-formed steel housing assembly.

## Finish

Polyester powder painted finish (textured matte white).

## Electrical

Long life LEDs coupled with high efficiency drivers provide quality illumination. Rated to deliver L80 performance >60,000 hours.

## Warranty

5 year limited warranty. For complete warranty, click here:



## Approvals

- Approved to CSA/UL standards.
- Suitable for damp locations

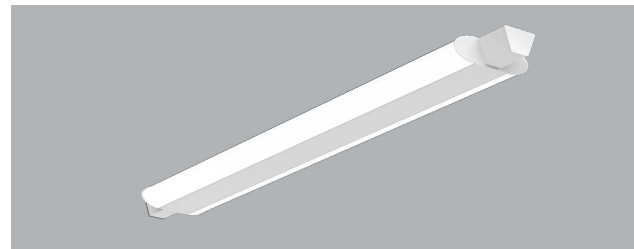

## Dimensions

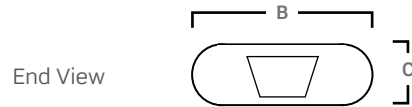
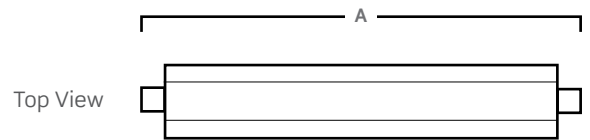

Size	A	B	C
48	51"	6 1/2"	2"
96	95"	6 1/2"	2"

Consult installation guide for exact dimensions.

Project:	Catalogue #:	Type:
Notes:		

## Order Key

### EXAMPLE: ALRA48-LED840K050LUNV-C91X

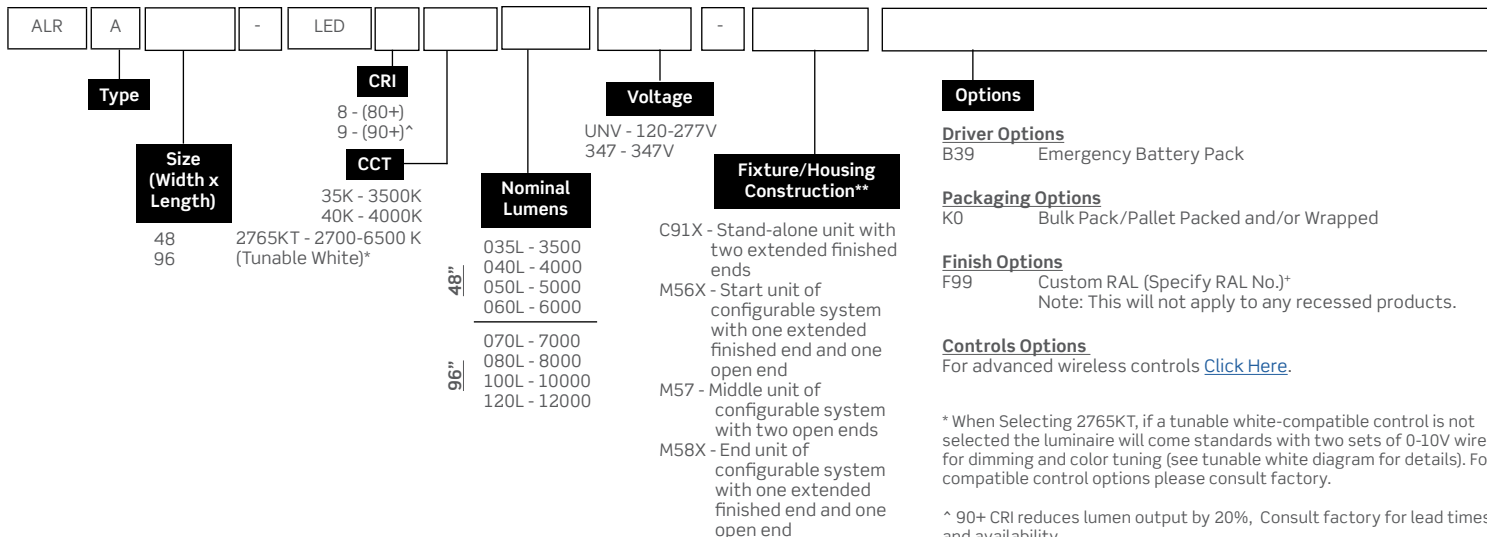

\* When Selecting 2765KT, if a tunable white-compatible control is not selected the luminaire will come standards with two sets of 0-10V wires for dimming and color tuning (see tunable white diagram for details). For compatible control options please consult factory.

<sup>^</sup> 90+ CRI reduces lumen output by 20%, Consult factory for lead times and availability.

+Minimum order quantity may apply. Consult factory.

\*\*For all stand-alone and configurable units, power feeds, canopies & air craft cables must be ordered separately. See "How to order" section for details.

Other options may be available, consult factory. Specifications and data subject to change without notice.

## Performance Data

LED Performance Data				
Size	Nominal Lumens	Delivered Lumens	Watts	Lumens Per Watt
48	3500	3525	23.8	148.2
	4000	4020	27.3	147.1
	5000	5031	34.8	144.8
	6000	6024	42.3	142.4
96	7000	7050	47.6	148.2
	8000	8040	54.6	147.1
	10000	10063	69.5	144.8
	12000	12048	84.6	142.4

Values based on 840K with standard lens at 25C

## Performance Scaling Factor

	50K	40K	35K	30K
80CRI	1.000	1.000	0.960	0.946
90CRI	0.875	0.875	0.836	0.809

## Lifetime Expectancy

	Calculated Hours	Reported Hours
L70	≥238,000	>60,000
L80	≥149,000	>60,000
L90	≥71,000	>60,000

## How to Order configurable system

**Step 1) Select desired unit from order key above**

Part #	Description
C91X	Stand-alone unit
M56X	Start Unit
M57	Middle Unit
M58X	End Unit

**Step 2) For configurable system only, select desired connector(s) or stand-alone models, see step 3.**

Part #	Description
KIT00171	Straight Connector
KIT00172	Elbow Connector (90 Degrees)
KIT00173	T Connector
KIT00174	Cross Connector

**Step 3) Select suspension kit(s) and power feed(s)\*\*\***

Part#	Description
KIT00188	48" Air Craft Cable & Canopy
KIT00189	5-Wire UNV Power Feed with 48" Air Craft Cable & Canopy
KIT00230+	6-Wire UNV Power Feed with 48" Air Craft Cable & Canopy (Emergency)
KIT00190	3-Wire 347V Power Feed with 48" Air Craft Cable & Canopy (Non-dimmable)
KIT00191	5-Wire 347V Power Feed with 48" Air Craft Cable & Canopy

\*\*\*One power feed is recommended for every 60 feet based on 6000 lumens unit on 120V 15A current.



\*\*\*For other suspension kit lengths, please consult factory.

+ Emergency suspension kit must be connected to the housing containing emergency battery pack.

Project:	Catalogue #:	Type:
Notes:		



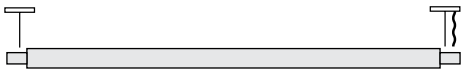

## Popular Configurations

### Stand-alone with flat ends

Part#	Description	Qty.
C91X		1
KIT00188		1
KIT00189		1





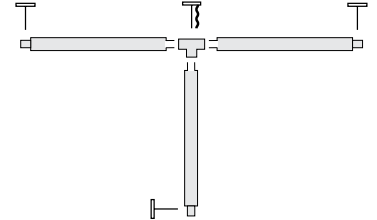

### Tee with flat ends

Part#	Description	Qty.
M58X Unit		3
KIT00188		3
KIT00189		1
KIT00173		1





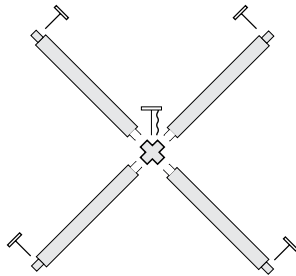

### Cross with flat ends

Part#	Description	Qty.
M58X Unit		4
KIT00188		4
KIT00189		1
KIT00174		1







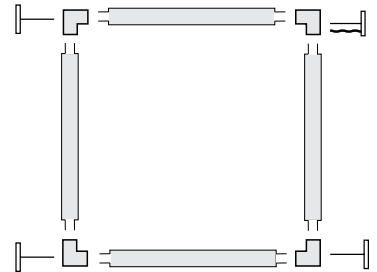

### Square / Rectangle

Part#	Description	Qty.
M57 Unit		4
KIT00188		3
KIT00189		1
KIT00172		4



### Row with flat ends

Part#	Description	Qty.
M56X Unit		1
M57 Unit		2
M58X Unit		1
KIT00188		4
KIT00189		1
KIT00171		3

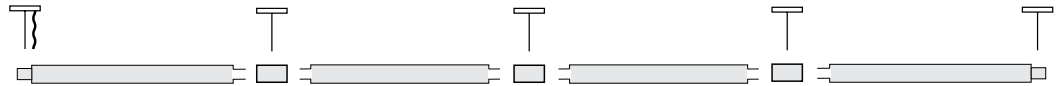

# Allura A Extended

LED - Linear Pendant A - Architectural Lighting

Project:	Catalogue #:	Type:
Notes:		

## Mounting Points

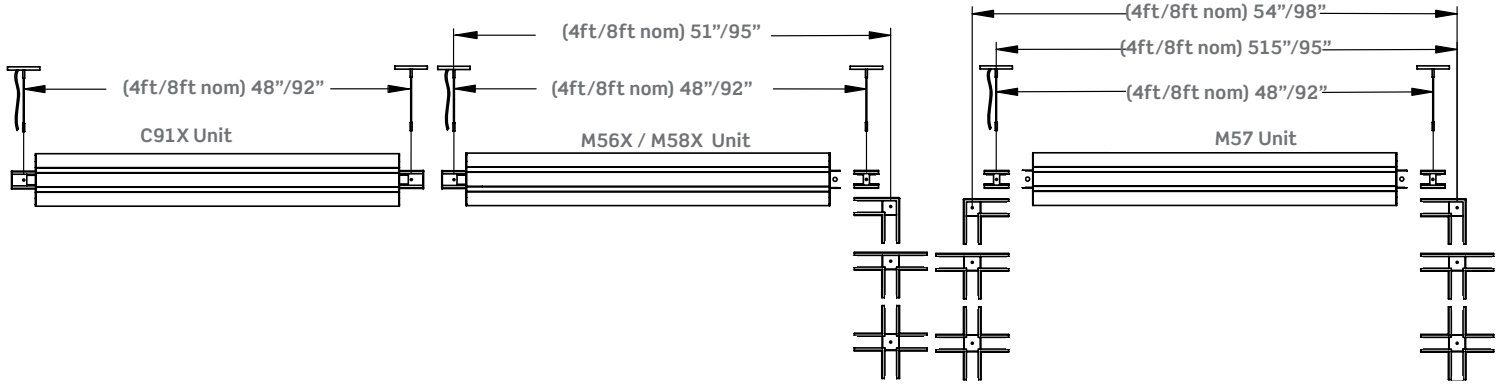

## Photometrics

IES File: **ALRA48-LED840K60LUNV**  
 Lumens: **5928**  
 Wattage: **47**  
 Efficacy: **126**

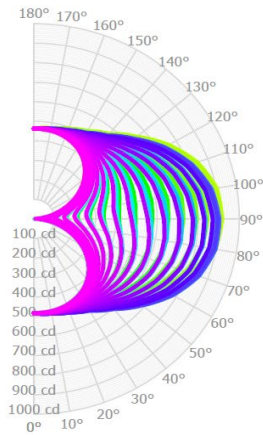

### Zonal Lumen Summary

Zone	Lumens	%Fixture
0.0° - 30.0°	412	7.0%
0.0° - 40.0°	723	12.2%
0.0° - 60.0°	1558	26.3%
0.0° - 90.0°	3031	51.1%
0.0° - 110.0°	3985	67.2%
0.0° - 130.0°	4873	82.2%
0.0° - 150.0°	5534	93.4%
0.0° - 170.0°	5883	99.2%
0.0° - 180.0°	5928	100.0%

### Coefficients of Utilization

pc	80%			70%			50%		
	70%	50%	30%	70%	50%	30%	70%	50%	30%
0	107	107	107	99	99	99	84	84	84
1	94	88	82	86	81	76	72	68	64
2	84	75	67	77	68	62	63	57	52
3	76	64	55	69	59	51	57	49	43
4	69	56	47	63	52	43	51	43	36
5	63	49	40	57	45	37	47	38	31
6	58	44	35	52	40	32	43	34	27
7	53	39	31	48	36	28	40	30	24
8	49	36	27	45	33	25	37	28	21
9	46	32	24	42	30	22	34	25	19
10	42	30	22	39	27	20	32	23	17

### Average Luminance Table (cd/m2) CP Summary

	0.00°	45.00°	90.00°
0.00°	2557	2557	2557
45.00°	2742	3276	4130
55.00°	2726	3796	5470
65.00°	2627	4610	7609
75.00°	2390	6157	11347
85.00°	1479	10408	20033

Effective Floor Cavity Reflectance: 20%

## Tunable White

When Selecting 2765KT, if a tunable white-compatible control is not selected the luminaire will come standard with two sets of 0-10V wires for dimming and color tuning. For compatible control options please consult factory.

Dim and CCT control wire colors are subject to change without notice. All control wires are marked per the parentheses.

