

Project:	Catalog:	Type:
Notes:		

### Product Description

The CRUi series by Certolux is a recessed luminaire that is certified IP65 and rated for ISO Class 3-8 cleanrooms. The inset door seals directly to the housing. It is triple gasketed, listed for wet locations and tested to 2500Psi washdown. The mounting is universal for 1.0" to 1.5" t-bar grid and flanged installations. It is certified NSF2 food, splash and non-food zones.

### Feature Options

- Plenum Access Panel
- Tunable White



### Housing

Precision formed, seam welded, one-piece, hole-free construction. 20 gauge cold rolled steel standard. Rigid 18 gauge flange with welded and rounded corners for safety. Stainless Steel and Aluminum are available options. 5 Stage pretreatment and gloss white polyester powder coated after fabrication. ASTM B117 1000hr Salt Spray tested.

### Door Frame

Inset one-piece door frame, fabricated from 18 gauge, cold rolled steel with welded corners. Countersunk flat head, stainless steel, captive fasteners with integral silicone o-rings. Door frame is removable, reversible, and hinged by stainless steel aircraft cables. High performance Poron™ gasket seals door frame to housing.

### Lens & Lens Retention

Standard lens; High impact 0.125" thick clear acrylic lens with diffuse inner layer provides symmetric distribution, (DSA). Smooth external surface for easy cleaning. Sealed to door frame with RTV silicone sealant and retained by continuous perimeter brackets. See order code for other options.

### Gasket Systems

Triple gasketed: Lens: RTV 100% pure silicone seals lens to door. Door: Highly resilient and chemical resistant Certaseal microcellular closed-cell gasket seals door frame to the housing. Housing: Closed cell neoprene gasket provided to seal flange to ceiling. Door screws: Silicone o-rings with special sealing flat-head screws.

### LED

LED board modules are high efficiency and closely regulated to maintain CRI, color consistency, lumen performance, and efficacy. Select from 3000K, 3500K, 4000K, and 5000K color temperatures with a color consistency of 3 SDCM, standard 80 CRI, optional 90 CRI. Tunable White CCT range is 2700-6500K. Lifetime L90 is greater than 60,000 hrs. Modules are field replaceable and commercially available. Optional amber and red LEDs arrays available alone or in combination with white LEDs. Tunable White options are also available. See specific CRUi white LED spec sheet [here](#).

### Electrical

The standard electronic driver is constant current, programmable and dimmable to 1% using a 0-10V protocol. High efficiency (>85%) and low THD (<10%). Certified to FCC Part 15, Class A. 120-277Vac or 347Vac, 50/60hz. See "Options" for Lutron™ or DALI driver choices. Internal Emergency Drivers are serviceable from the room side unless otherwise noted. Each LED color is separately circuited.

### Finish

5 Stage pretreatment and gloss white polyester powder coated after fabrication. ASTM B117 1000hr Salt Spray tested. Stainless Steel is available with a choice of brushed #4 polished finish or gloss white polyester powder coated.

### Installation

Flange installation is supported by swing style mounting brackets. Bracket vertical range is 1.3-2.9 inches. Grid installation suitable for 1" and 1.5" T-Bar NEMA LE4 Type G ceilings. See ordering key for use with 2" T-Bar Grid systems. (option C57) Consult factory for compatibility with non-standard grid systems). Ambient operating temperature: -4°F (-20°C) to 104°F (40°C).

### Listings, Certifications and Ratings

UL listed for wet locations under covered ceiling (CAN & USA, ANSI/UL1598 & UL8750). Recessed Type IC for insulated ceilings. NSF2 for Food, Splash and non-food zones. IEC60529 IP65 (Certified dust-tight and resistant to jets of water). Cleanroom classified ISO3-8. EU GMP Grade A, Suitable for Biosafety BSL1-2. (See overlapping door for BSL1-3) Compliant with CCEA requirements. Rated for 2500psi washdown conditions.

### Warranty

5 year limited warranty. For complete warranty, 5YR Warranty

### Approvals

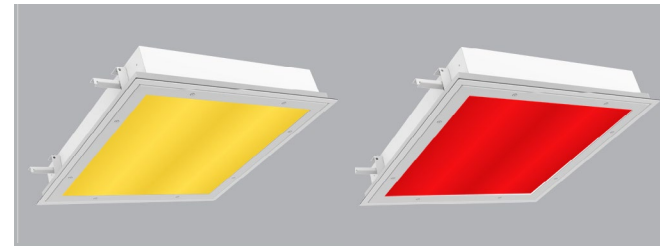

### Dimensions

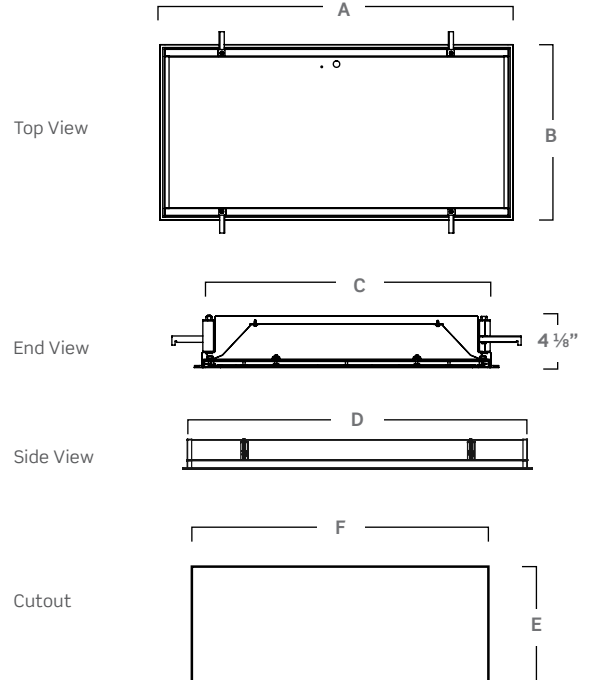

	Dimensions (inch) & Weights						Weight
	A	B	C	D	E	F	
1x4	47.75	11.75	10.69	46.75	10.69	46.75	32 lbs.
2x2	23.75	23.75	22.69	22.88	22.69	22.88	29 lbs.
2x4	47.75	23.75	22.69	46.75	22.69	46.75	50 lbs.

Consult installation guide for exact dimensions.

Project:	Catalog:	Type:
Notes:		

### Order Key

#### EXAMPLE: CRUi2x4A/PLED840K100LUNV-DSA

<p><b>CRU</b>   <b>i</b>   Door / Hsg   <b>LED</b>   <b>DSA</b></p> <p><b>Series</b> Type i - Inset</p> <p><b>Size</b> 1x4 2x2 2x4</p> <p><b>Material Door</b> P = 20 Ga. CRS Painted A = 18 Ga. CRS Painted (Std.) R = 20 Ga. 304 SS #4 Brushed T = 20 Ga. 304 SS Painted E = 18 Ga. 304 SS Painted H = 18 Ga. 304 SS #4 Brushed L = 18 Ga. 316 SS Painted Q = 18 Ga. 316 SS #4 Brushed U = .050" Aluminum Painted</p> <p><b>Material Housing</b> T = 20 Ga. 304 SS Painted P = 20 Ga. CRS Painted (Std.) L = 18 Ga. SS #316 Painted U = .050" Aluminum Painted</p>	<p><b>CRI***</b> 8 - (80+) 9 - (90+)</p> <p><b>CCT</b> 30K - 3000 K 35K - 3500 K 40K - 4000 K 50K - 5000 K 2765KT-2700-6500K** (Tunable White)</p>	<p><b>LED Selection</b> Choose from charts below (next page) "Order Code"</p> <p><b>Voltage</b> UNV - 120-277V 347 - 347V</p>	<p><b>Options</b></p> <p><b>Driver Options</b> B02 Dimming Addressable Digital (DALI) B39 Emergency Bat. Pack -LED 10 Watts* B39(ST) Emergency Bat. Pack, Self Testing -LED 10 Watts*</p> <p><b>Wiring Options</b> V25 Radio Frequency Filter V33 Two Circuit Switching V55 Sealed wireway V68 Microwave Occupancy Sensor</p> <p><b>Construction Options</b> C21 Plenum Access Panel (Gasketed) C57 Hsg. For 2" T-bar (Consult factory for compatibility)</p> <p><b>Finish Options (Gloss White Standard)</b> F47 Gloss White Antimicrobial C77 White Stainless Steel Door Screws</p> <p><b>Accessories</b> M46 Continuous Row Mtg. -Not Required for Grid</p> <p><b>Approval and Rating Options</b> X19 Deduct NSF Listing</p> <p>* Standard emergency battery pack options are internal and serviced from the room side. The exception is for some 2x2 wattages may have remote battery packs. Consult factory for details regarding 2x2 with emergency pack options.</p> <p>** When Selecting 2765KT, if a tunable white-compatible control is not selected the luminaire will come standards with two sets of 0-10V wires for dimming and color tuning. For compatible control options please consult factory.</p> <p>*** For a fixture with only Red or Amber LEDs (no white LEDs) omit the CCT and CRI choices and replace with a dash line (-).</p>
--	--	---	--

### Installation Details

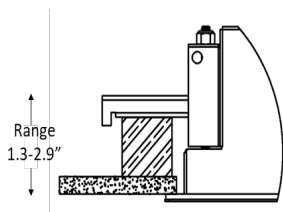

Inset Door Flanged  
(Framing by others)

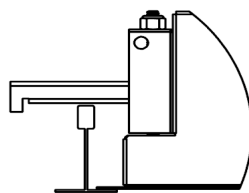

Inset Door in T-bar Grid Ceiling

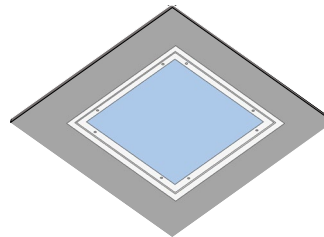

Inset Door Flanged

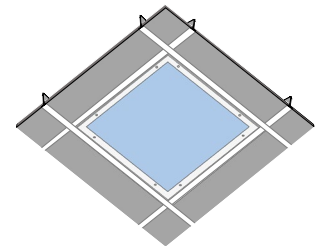

Inset Door in T-bar Grid Ceiling

Project:	Catalog:	Type:
Notes:		

Red & White Performance Data							
Size	Order Code	White LED Performance*			RED Performance		Total System Watts
		Lumens	Watts	Efficacy	Lumens	Watts	
1x4	35L / 10R	3585	32	112	1000	31	63
	55L / 10R	5538	51	109	1000	31	82
	70L / 10R	7064	68	104	1000	31	99
2x2	35L / 10R	3564	31	115	1000	30	61
	55L / 10R	5571	50	111	1000	30	80
	70L / 10R	7035	65	108	1000	30	95
2x4	55L / 10R	5517	45	123	1000	27	72
	55L / 20R	5517	45	123	2000	62	107
	70L / 10R	7085	59	120	1000	27	86
	70L / 20R	7085	59	120	2000	62	121
	100L / 10R	10093	80	126	1000	27	107
	100L / 20R	10093	80	126	2000	62	142
	120L / 10R	12096	99	122	1000	27	126
	120L / 20R	12096	99	122	2000	62	161
180L / 10R	18103	143	127	1000	27	170	

RED only LED Performance Data			
Size	Order Code	Lumens	Watts
1x4	-/10R	1000	31
2x2	-/10R	1000	30
2x4	-/10R	1000	27
	-/20R	2000	62

Omit CRI and CCT order codes when selecting a red or amber only fixture (without white LEDs).

Amber & White Performance Data							
Size	Order Code	White LED Performance*			AMBER Performance		Total System Watts
		Lumens	Watts	Efficacy	Lumens	Watts	
1x4	35L / 35A	3585	32	112	3500	47	79
	35L / 55A	3585	32	112	5500	74	106
	35L / 70A	3585	32	112	7000	94	126
	70L / 35A	7064	68	104	3500	47	115
2x2	35L / 35A	3564	31	115	3500	46	77
	35L / 55A	3564	31	115	5500	76	107
	55L / 70A	3564	31	115	7000	97	128
	70L / 35A	7035	65	108	3500	46	111
2x4	55L / 35A	5517	45	123	3500	41	86
	55L / 55A	5517	45	123	5500	61	106
	55L / 70A	5517	45	123	7000	81	126
	70L / 35A	7085	59	120	3500	41	100
	70L / 55A	7085	59	120	5500	61	120
	70L / 100A	7085	59	120	10000	122	181
	100L / 35A	10093	80	126	3500	41	121
	100L / 55A	10093	80	126	5500	61	141
	100L / 70A	10093	80	126	7000	81	161
	100L / 100A	10093	80	126	10000	122	202

AMBER only LED Performance Data			
Size	Order Code	Lumens	Watts
1x4	-/35A	3500	47
	-/55A	5500	74
	-/70A	7000	94
2x2	-/35A	3500	46
	-/55A	5500	76
	-/70A	7000	97
2x4	-/35A	3500	41
	-/55A	5500	61
	-/70A	7000	81
	-/100A	10000	122

For a fixture with only Red or Amber LEDs (no white LEDs) omit the CCT and CRI choices and replace with a dash line (-).

\* Lumen values are based on 4000K, 80 CRI performance.  
See Lumen Multipliers below for other CCT or CRI performance data.

Project:	Catalog:	Type:
Notes:		

### Photometric Performance

#### CRUI-2X4-LED840K120LUNV-DSA

Characteristics	
Luminaire Lumens	12096
Efficacy Rating	122
Total Luminaire Watts	99
Spacing Criterion (0-180)	1.2
Spacing Criterion (90-270)	1.18
Spacing Criterion (Diagonal)	1.3

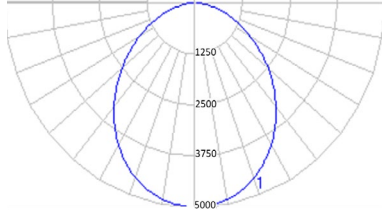

Luminance Data (cd/sq.m)				
Degrees	0-Deg	45-Deg	90-Deg	
45	5674	5695	5291	
55	5043	4729	4612	
65	4212	3863	3743	
75	2972	2572	2543	
85	896	1142	1458	

Zonal Lumens	
Zone	Lumens
0-30	3747.51
0-40	6011.17
0-60	10073
0-90	12096
90-180	0

#### CRUI-2X2-LED840K070LUNV-DSA

Characteristics	
Luminaire Lumens	7035
Efficacy Rating	108
Total Luminaire Watts	65
Spacing Criterion (0-180)	1.2
Spacing Criterion (90-270)	1.18
Spacing Criterion (Diagonal)	1.3

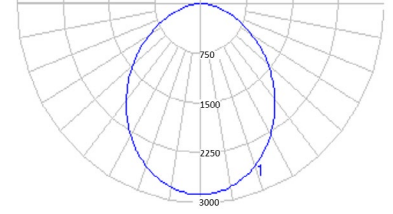

Luminance Data (cd/sq.m)				
Degrees	0-Deg	45-Deg	90-Deg	
45	6551	6397	6399	
55	5884	5702	5685	
65	4956	4722	4700	
75	3437	3148	3269	
85	1130	1443	1988	

Zonal Lumens	
Zone	Lumens
0-30	2161
0-40	3468
0-60	5845
0-90	7035
90-180	0

#### CRUI-2X4-LED840K-/70AUNV-DSA

Characteristics	
Luminaire Lumens	7002
Efficacy Rating	86.4
Total Luminaire Watts	81
Spacing Criterion (0-180)	1.2
Spacing Criterion (90-270)	1.18
Spacing Criterion (Diagonal)	1.3

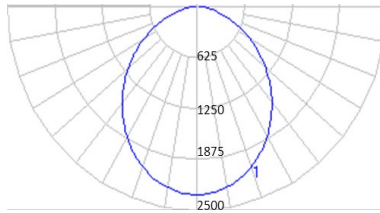

Luminance Data (cd/sq.m)				
Degrees	0-Deg	45-Deg	90-Deg	
45	3281	3131	3082	
55	2914	2750	2688	
65	2432	2248	2185	
75	1712	1501	1485	
85	514	655	856	

Zonal Lumens	
Zone	Lumens
0-30	2169
0-40	3480
0-60	5833
0-90	7002
90-180	0

#### CRUI-2X4-LED840K-/20RUVN-DSA

Characteristics	
Luminaire Lumens	2000
Efficacy Rating	32
Total Luminaire Watts	62
Spacing Criterion (0-180)	1.2
Spacing Criterion (90-270)	1.17
Spacing Criterion (Diagonal)	1.3

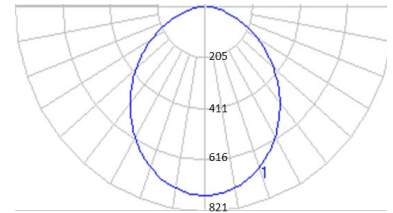

Luminance Data (cd/sq.m)				
Degrees	0-Deg	45-Deg	90-Deg	
45	937	894	880	
55	832	785	768	
65	695	642	624	
75	498	429	424	
85	147	187	244	

Zonal Lumens	
Zone	Lumens
0-30	619
0-40	993
0-60	1665
0-90	2000
90-180	0

AMBER	
Purity	96%
Peak (λ)	604nm
Radiometric Power <480nm	0.80%
UV Output	0.000%
FWHM (Bandwidth)	89nm

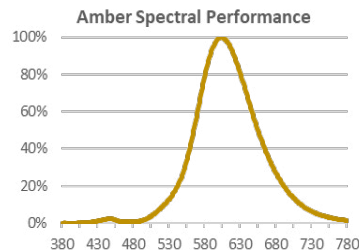

RED	
Purity	100%
Peak (λ)	635nm
Radiometric Power <480nm	0.03%
UV Output	0.000%
FWHM (Bandwidth)	18nm

