

Project:	Catalog#:	Type:
Notes:		

Product Description

The CRU series by Certolux is a recessed luminaire that is certified IP65 and rated for ISO Class 3-8 cleanrooms. The inset door seals directly to the housing, while the overlapping door seals to the ceiling and housing, completely covering the fixture flange. It is triple gasketed, listed for wet locations and tested to 2500Psi washdown. The mounting is universal for 1.0" to 1.5" t-bar grid and flanged installations. It is certified NSF2 food, splash and non-food zones.

Options

This SpeedShip version has a reduced set of options to assure a quick delivery. For an wide array of options see the CRU standard specification sheet.

Housing

Precision formed, seam welded, one-piece, hole-free construction. 20 gauge cold rolled steel standard. Rigid 18 gauge flange with welded and rounded corners for safety. 5 Stage pretreatment and gloss white polyester powder coated after fabrication. ASTM B117 1000hr Salt Spray tested.

Door Frame

INSET - Inset one-piece door frame, fabricated from 18 gauge, cold rolled steel with welded corners. Countersunk flat head, stainless steel, captive fasteners with integral silicone o-rings. Door frame is removable, reversible, and hinged by stainless steel aircraft cables. High performance Poron™ gasket seals door frame to housing.

OVERLAPPING - Overlapping one-piece 18 gauge cold rolled steel standard, optional types 304 or 316 stainless steel or aluminum. welded corners blended smooth. Countersunk flat head, stainless steel, captive fasteners with integral silicone o-rings. Door frame is removable, reversible, and hinged by stainless steel aircraft cables. Highly resilient and chemical resistant CertaSeal microcellular closed-cell gasket seals door frame to the housing and/or ceiling.

Lens & Lens Retention

High diffusion inside layer and impact resistant 0.125" thick polycarbonate outer lens provides symmetric distribution. Smooth external surface for easy cleaning. Sealed to doorframe with RTV silicone sealant.

Gasket Systems

Triple gasketed: Lens: RTV 100% pure silicone seals lens to door. Door: High performance Poron™ gasket seals door frame to housing. Housing: Closed cell neoprene gasket provided to seal flange to ceiling. Door screws: Silicone o-rings with special sealing flat-head screws.

LED

LED board modules are high efficiency and closely regulated to maintain CRI, color consistency, lumen performance, and efficacy. Select from 3500K or 4000K color temperatures with a color consistency of 3 SDCM, standard 80+ CRI. Lifetime L90 is greater than 60,000 hrs. Modules are field replaceable and commercially available.

Electrical

The standard electronic driver is constant current, programmable and dimmable to 1% using a 0-10V protocol. High efficiency (>85%) and low THD (<10%). Certified to FCC Part 15, Class A. 120-277Vac or 347Vac, 50/60hz.

Finish

5 Stage pretreatment and gloss white polyester powder coated after fabrication. ASTM B117 1000hr Salt Spray tested. Stainless Steel is available with a choice of brushed #4 polished finish or gloss white polyester powder coated.

Installation

Flange installation is supported by swing style mounting brackets. Bracket vertical range is 1.3-2.9 inches. Grid installation suitable for 1" and 1.5" T-Bar NEMA LE4 Type G ceilings. Consult factory for compatibility with non-standard grid systems). Ambient operating temperature: -4°F (-20°C) to 104°F (40°C).

Listings, Certifications and Ratings

UL listed for wet locations under covered ceiling (CAN & USA, ANSI/UL1598 & UL8750). Recessed Type IC for insulated ceilings. NSF2 for Food, Splash and non-food zones. IEC60529 IP65 (Certified dust-tight and resistant to jets of water). Cleanroom classified ISO3-8. EU GMP Grade A, Suitable for Biosafety BSL1-2. (See overlapping door for BSL1-3) Compliant with CCEA requirements. Rated for 2500psi washdown conditions.

Warranty

5 year limited warranty. For complete warranty,



Approvals

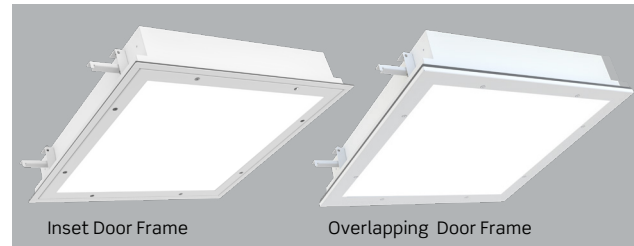

Dimensions

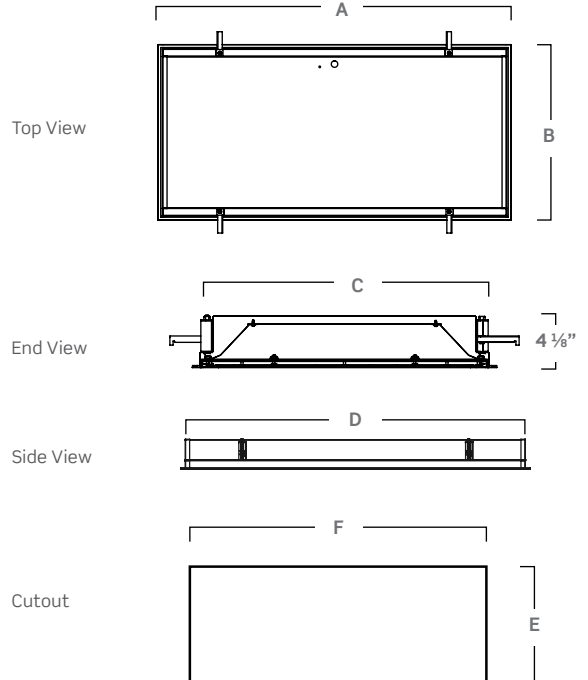

	Dimensions (inch) & Weights						
	A	B	C	D	E	F	Weight
1x4	47.75	11.75	10.69	46.75	10.69	46.75	32 lbs.
2x2	23.75	23.75	22.69	22.88	22.69	22.88	29 lbs.
2x4	47.75	23.75	22.69	46.75	22.69	46.75	50 lbs.

Consult installation guide for exact dimensions.

Project:	Catalog#:	Type:
Notes:		

Order Key

EXAMPLE: CRUi2x4A/PLED840K100LUNV-DSA

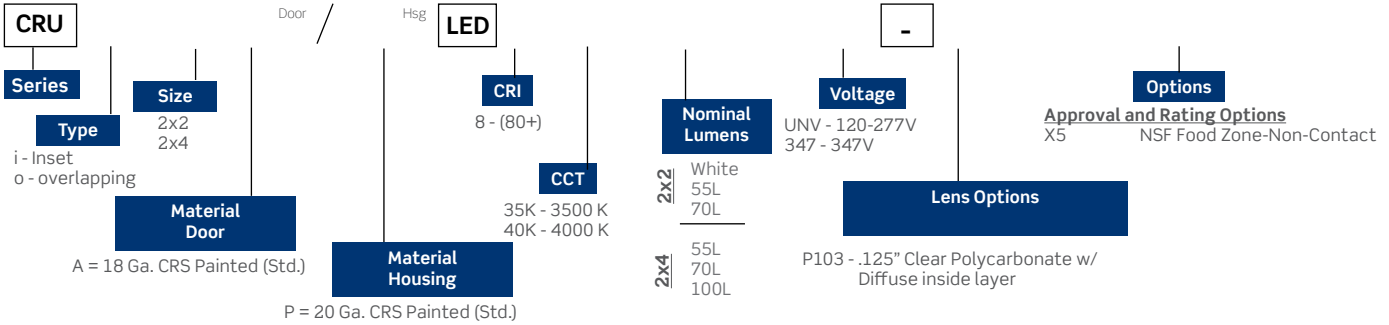

Performance Data				
White LED Performance*				
Size	Nominal Lumens Order Code	Lumens (4000K)	Watts	Efficacy
2x2	55L	5571	50	111
	70L	7035	65	108
2x4	55L	5517	45	123
	70L	7085	59	120
	100L	10093	80	126

* Lumen values are based on 4000K, 80 CRI performance. See Lumen Multipliers below for other CCT or CRI performance data.

Installation Details

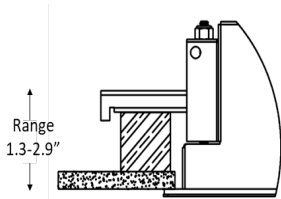

Inset Door Flanged (Framing by others)

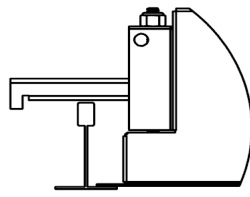

Inset Door in T-bar Grid Ceiling

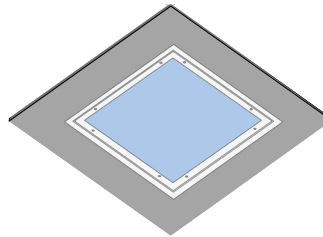

Inset Door Flanged

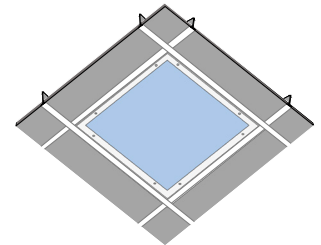

Inset Door in T-bar Grid Ceiling

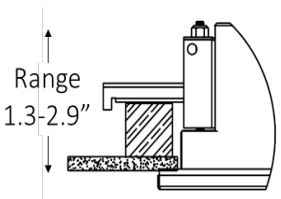

Overlapping Door Flanged (Framing by others)

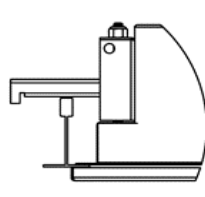

Overlapping Door in Grid Ceiling

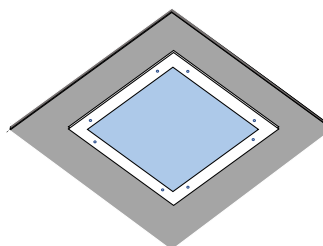

Overlapping Door Flanged

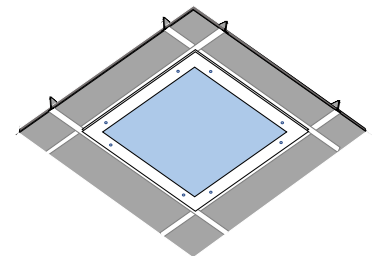

Overlapping Door in Grid Ceiling