



Troffer Wireless Integration Guide

Ver. 1 (Includes LRTB, LRTC, LRTF, LRTG, ClearForm, LRTH, LRTJ, LRTZ, Bevel, Revel)

Legend

-  Fixture Modification
-  Assembly Adder

FACTORY INSTALLATION



Intellect Wireless Sensor

- Option V99(LV04)
- ZL07S-N00 - 0-10V
- ZL07S-N00 - Dali

Sensor

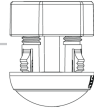

Control

Driver

Manufacturing

Modules

0-10V w/Aux (Default)

DEXAL (Dali)
Option B41

Philips SR (Dali)
Option B43



Intellect Wireless Sensor Tunable White

- Option V99(LV04) - ZL0DS-N00

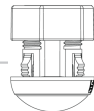

DEXAL TW (Dali)
Option B41

Philips SR Flextune (Dali)
Option B43

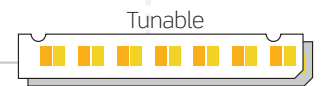

Intellect Wireless Controller

- Option V99(LV05)
- ZL070-B00 0-10V
- ZL0D0-B00 Dali

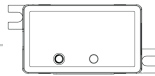

0-10V w/Aux (Default)

DEXAL (Dali)
Option B41

Philips SR (Dali)
Option B43



Intellect Wireless Controller 2-chanel Tunable White

- Option V99(LV05)
- ZL070-B20 - 2x0-10V
- ZL0D0-B00 - Dali

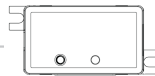

2CH 0-10V TW

DEXAL TW (Dali)
Option B41

Philips SR Flextune (Dali)
Option B43

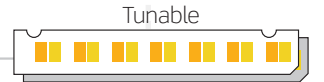

Intellect Wireless Controller

- Option V99(LV06)
- ZL070-N00 0-10V
- ZL0D0-N00 Dali



0-10V w/Aux (Default)

DEXAL (Dali)
Option B41

Philips SR (Dali)
Option B43



Intellect Wireless Controller Tunable

- Option V99(LV06) - ZL0D0-N00 Dali



DEXAL TW (Dali)
Option B41

Philips SR Flextune (Dali)
Option B43

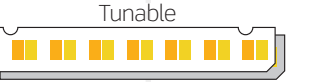

Troffer Wireless Integration Guide

Ver. 1 (Includes LRTB, LRTC, LRTF, LRTG, ClearForm, LRTH, LRTJ, LRTZ, Bevel, Revel)

Legend

-  Fixture Modification
-  Assembly Adder

FACTORY INSTALLATION

ENCELIUM

Connected Lighting Module (CLM)
 • Option V99(S01) - ZBHA-CLM-DIM

Connected Lighting Module (CLM)
 • Option V99(S02) - ZBHA-CLMDEXAL

SensiLUM™ Wireless Integrated Sensor
 • Option V99(S05) - SensiLUM

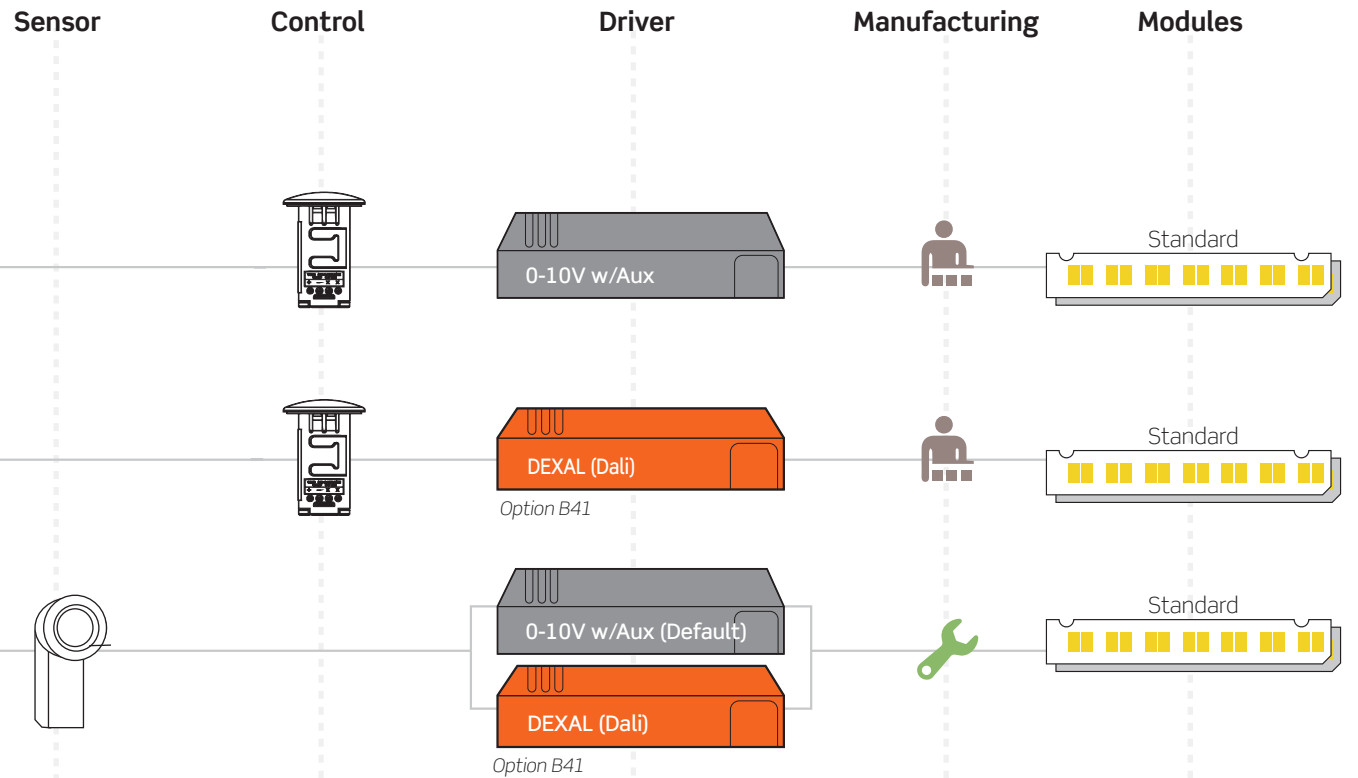

FACTORY OR IN-FIELD INSTALLATION

Wireless Control Module (WCM)
 • Option V99(S03) - EN-WCM-ZB

Wireless Area Lighting Controller (WALC)
 • Option V99(S04) - EN-WALC-ZB

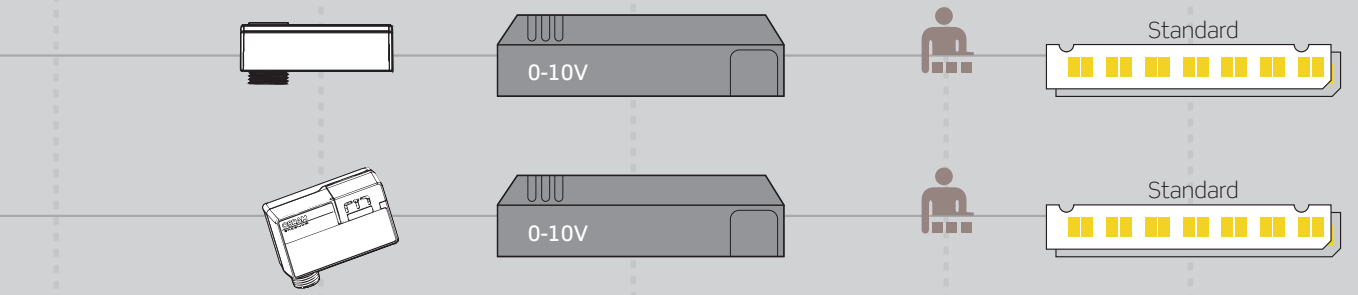

JDRF

ELECTROMAG

JDRF Autonomy Sensor
 • Option V99(JD01) - Black
 • Option V99(JD02) - White

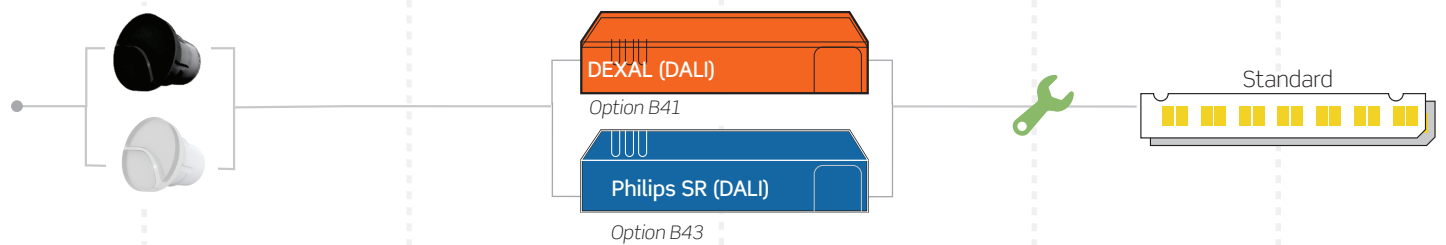

enlighted

Enlighted Micro Sensor
 • V99(E04) - SU-5E-CL

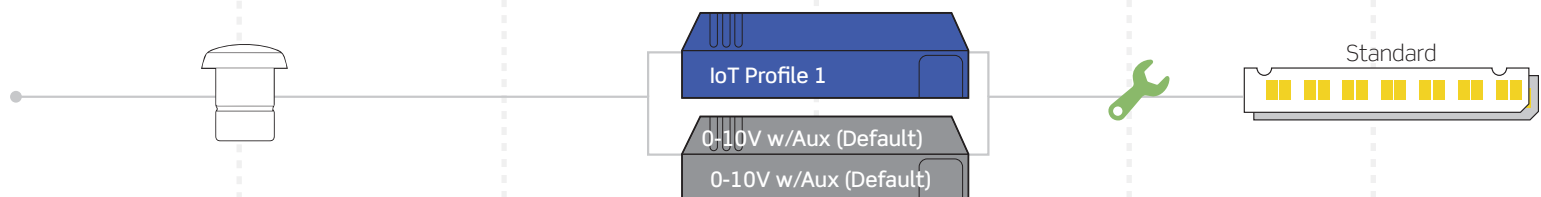

EasySense by PHILIPS

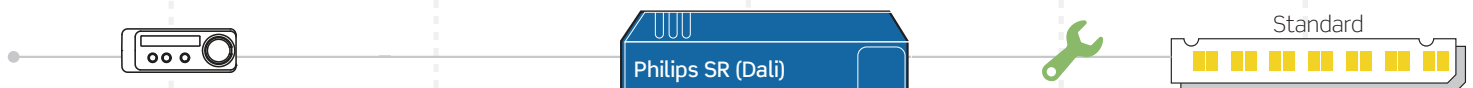

Philips EasySense Mount Sensor
 • Option V99(P02) - SNS211MC



Troffer Wireless Integration Guide

Ver. 1 (Includes LRTB, LRTC, LRTF, LRTG, ClearForm, LRTH, LRTJ, LRTZ, Bevel, Reveal)

Legend

-  Fixture Modification
-  Assembly Adder

FACTORY INSTALLATION

CASAMBI

- Casambi Bluetooth Controller
- Option V99(C01) - CBU-ASR

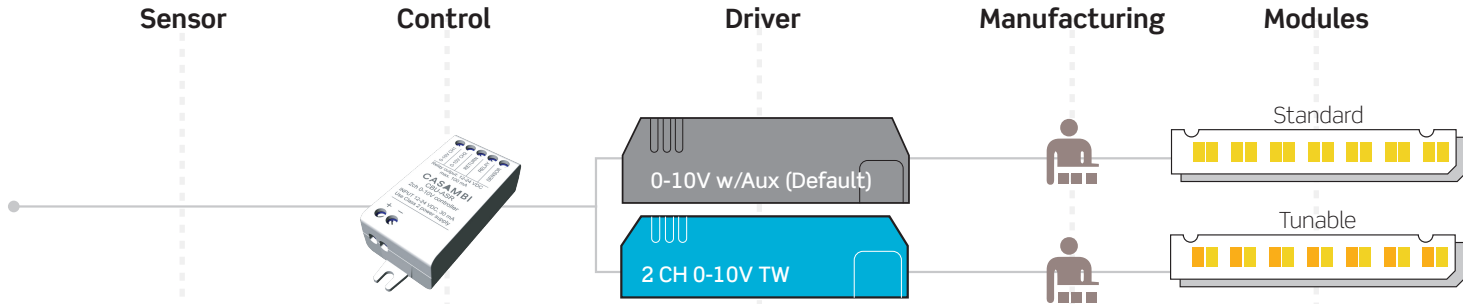

- Acuity nLight Dimming Device
- Option V99(A01) - n10-EZ-PH

- Acuity nLight Dimming Device with EM Functionality
- Option V99(A02) - n10-EZ-PH-EM

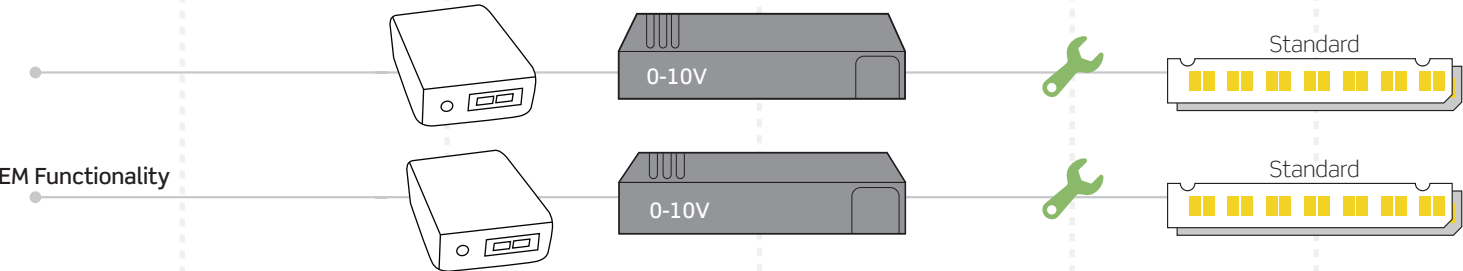

- EnergyCenter Zigbee Controller
- Option V99(AU01) - S830

- EnergyCenter Zigbee MultiSensor
- Option V99(AU02) - S830-PL

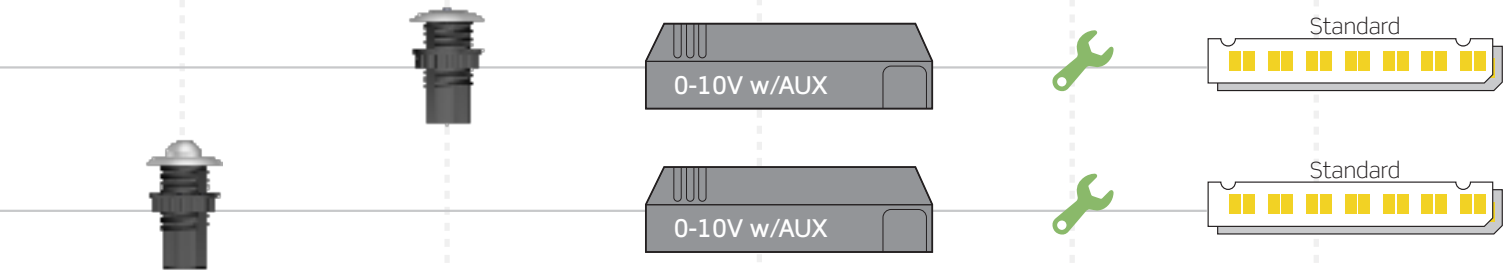

Wireless Integration Guide

Legend

- Fixture Modification
- Assembly Adder

Example Order Key

- LRTH2X2-LED840K032LUNV-B40(DS-1)V99(L06)
- Hi-lume 1% EcoSystem Driver & DFCSJ-OEM-OCC

FACTORY INSTALLATION

LUTRON

Lutron Vive Wireless Integral Fixture Controller

- Option V99(L05) - RF (DFCSJ-OEM-RF)
- Option V99(L06) - Daylight with Occupancy (DFCSJ-OEM-OCC)

Lutron Vive Wireless Integral Fixture Controller with EcoSystem

- Option V99(L05) - RF (DFCSJ-OEM-RF)
- Option V99(L06) - Daylight with Occupancy (DFCSJ-OEM-OCC)

Lutron LD2 Tunable White Driver

- Option B40(T)

Athena Wireless Node Sensor

- Option V99(L09) - SENSOR (White)
- Option V99(L10) - SENSOR (Black)

Athena Wireless Node Sensor

- Option V99(L09) - SENSOR (White)
- Option V99(L10) - SENSOR (Black)

Athena Wireless Node RF Only

- Option V99(L07) - A-WN-D01-RF-WH
- Option V99(L08) - A-WN-D01-RF-BL

Athena Wireless Node RF Only

- Option V99(L07) - A-WN-D01-RF-WH
- Option V99(L08) - A-WN-D01-RF-BL



FACTORY OR IN-FIELD INSTALLATION*

Lutron Vive Wireless Individual Fixture Controller

- Option V99(L02) - 0-10V (FCJS-010)

Lutron Vive Wireless Individual Fixture Controller with EcoSystem

- Option V99(L01) - EcoSystem (FCJS-ECO)

Lutron Vive Wireless Individual Fixture Controller

- Option V99(L03) - Occupancy (FC-SENSOR)
- Option V99(L04) - Vacancy (VSENSOR)

Lutron Vive Wireless Individual Fixture Controller with EcoSystem

(FC-SENSOR or VSENSOR)

*These options can be purchased from others and installed in-field. Options ordered from factory will be factory installed wherever possible.

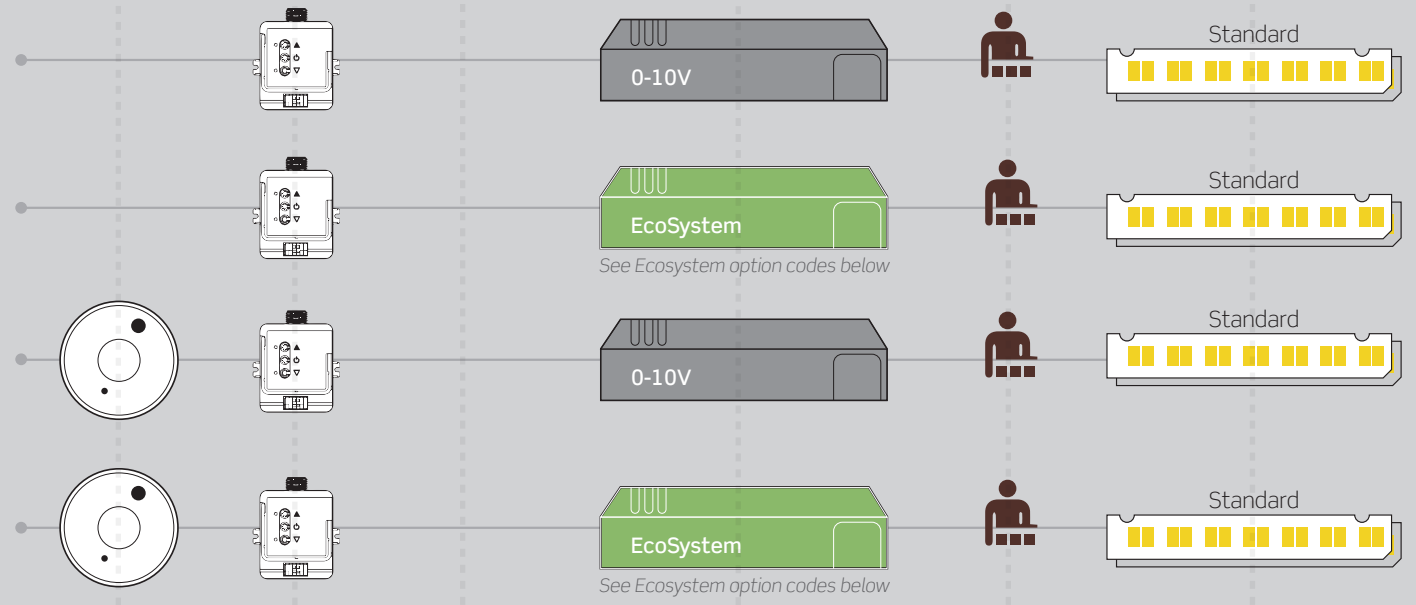

TUNABLE WHITE & STATIC WHITE DRIVERS

347V available, consult factory.

LD2 series 1%

B40(LD2)

Hi-lume 0.1%

Hi-lume Premier EcoSystem
0.1% w/ Soft-on, Fade-to-Black
Option B40(DS-0.1)

Hi-lume 1%

Hi-lume 1% EcoSystem
w/ Soft-on, Fade-to-Black
Option B40(DS-1)