

# ALLURA A EXTENDED

LED Linear Pendant A

LED

ARCHITECTURAL LIGHTING



VISIONEERING

by VISCOR

Project:	Catalogue #:	Type:
Notes:		

## Product Description

Premium-grade, pendant-mount, bi-directional luminaire. The Allura features an architectural slim profile with soft curves to enhance the visual space, and is available with row-mounting capability. This pendant-mount luminaire comes with a double teardrop shaped frosted diffuser that offers a high level of efficiency and visual comfort.

## Features

- Double teardrop extruded diffusers
- Standard low voltage dimming (0-10v, 1%)
- Suitable for row-mounting
- Standard 4-ft 5-wire white cord

## Applications

- Boardrooms
- Corridors
- Retail Stores and Supermarkets
- Studio Lofts
- Offices

## Featured Options

- Aircraft cable power feed suspension kit
- Emergency lighting battery pack



## Optical System

Frosted acrylic diffuser offer high levels of efficiency and visual comfort. The bi-directional optics provide a wide, uniform light distribution. Standard distribution is 50% up and 50% down.

## Mounting

Single-point aircraft cable mounting system used at each hanging location.

## Construction

Precision-formed steel housing assembly.

## Finish

Polyester powder painted finish (textured matte white).

## Electrical

Long life LEDs coupled with high efficiency drivers provide quality illumination. Rated to deliver L80 performance > 50,000 hours.

## Warranty

5 year limited warranty. For complete warranty terms visit: [http://viscor.com/assets/Viscor\\_LED\\_Warranty.pdf](http://viscor.com/assets/Viscor_LED_Warranty.pdf)

## Approvals

Approved to CSA/UL standards.  
Suitable for damp locations.



## Dimensions

Top View



End View

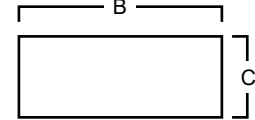

Size (Nominal Length)	A	B	C
48	51"	6 1/2"	2"
96	95"	6 1/2"	2"

Consult installation guide for exact dimensions.

# ALLURA A EXTENDED

LED Linear Pendant A

LED

ARCHITECTURAL LIGHTING



VISIONEERING

by VISCOR

Project:	Catalogue #:	Type:
Notes:		

## Order Key

EXAMPLE: ALRA48-LED840K050LUNV-C91X

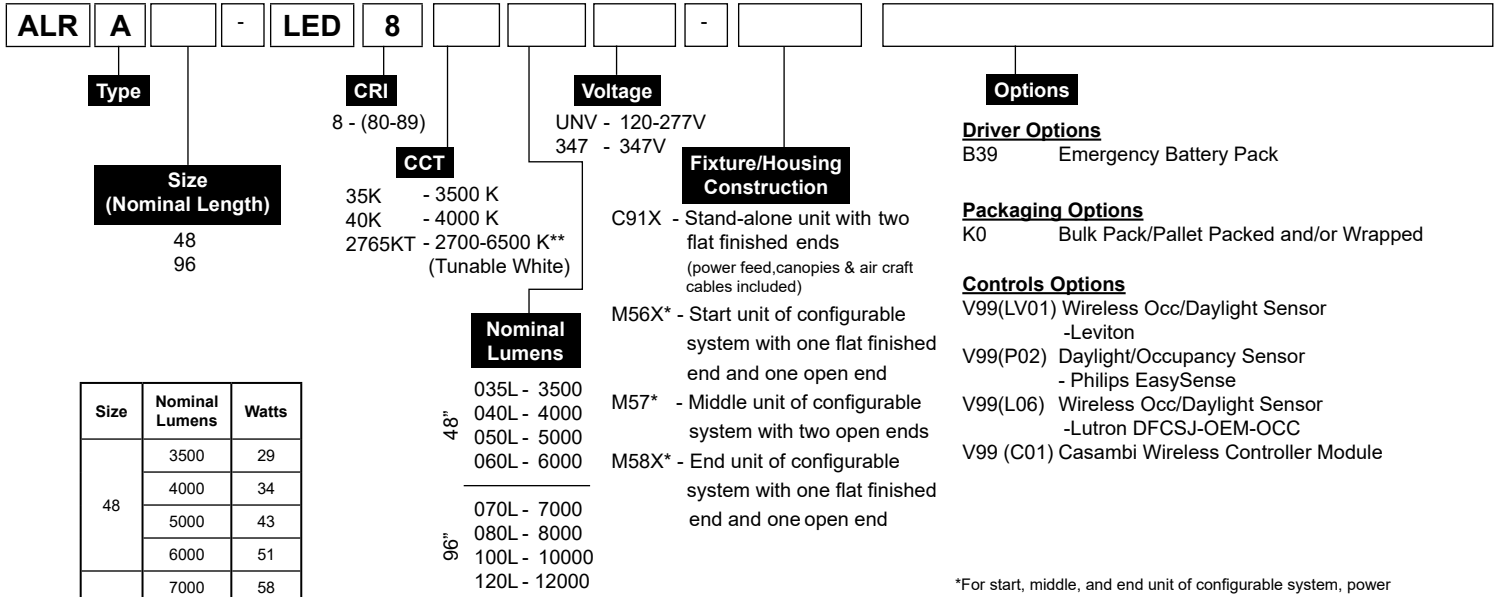

Size	Nominal Lumens	Watts
48	3500	29
	4000	34
	5000	43
	6000	51
96	7000	58
	8000	68
	10000	86
	12000	102

Nominal Lumens	Watts
035L - 3500	29
040L - 4000	34
050L - 5000	43
060L - 6000	51
070L - 7000	58
080L - 8000	68
100L - 10000	86
120L - 12000	102

\*For start, middle, and end unit of configurable system, power feeds, canopies & air craft cables ordered separately. See "How to order" section

\*\*When Selecting 2765KT, if a tunable white-compatible control is not selected the luminaire will come standard with two sets of 0-10V wires for dimming and color tuning. For compatible control options please consult factory.

Other options may be available, consult factory. Specifications and data subject to change without notice.

## How to order

**Step 1)** Select desired **unit** using order key above

Part #	Description
C91X	Stand-alone
M56X	Start Unit
M57	Middle Unit
M58X	End Unit

**Step 2)** For configurable system, select desired **connector(s)**

Part #	Description
KIT00171	Straight Connector
KIT00172	Elbow Connector (90 Degrees)
KIT00173	T Connector
KIT00174	Cross Connector

**Step 3)** For configurable system, select **suspension kit(s)**\*\*\* and power feed(s)

Part #	Description
KIT00188	48" Air Craft Cable & Canopy
KIT00189	5-Wire UNV Power Feed with 48" Air Craft Cable & Canopy
KIT00190	3-Wire 347V Power Feed with 48" Air Craft Cable & Canopy (Non-dimmable)
KIT00191	5-Wire 347V Power Feed with 48" Air Craft Cable & Canopy

\*\*\*One power feed is recommended for every 60 feet based on 6000 lumens unit on 120V 15A current

\*\*\*For other suspension kit lengths, please consult factory.

# ALLURA A EXTENDED

LED Linear Pendant A

LED

ARCHITECTURAL LIGHTING



**VISIONEERING**

by VISCOR

Project:	Catalogue #:	Type:
Notes:		

## Popular Configurations





### Stand-alone with flat ends

(power feed, canopies & air craft cables included)

Part #	Description	Qty.
C91X		1





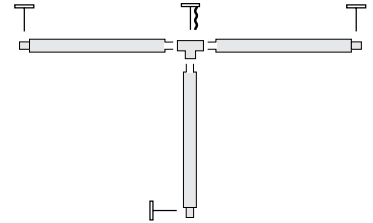

### Tee with flat ends

Part #	Description	Qty.
M58X Unit		3
KIT00188		3
KIT00189		1
KIT00173		1

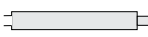



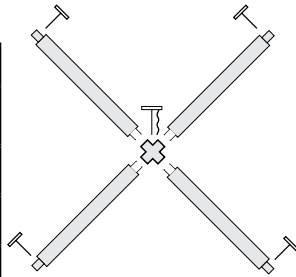

### Cross with flat ends

Part #	Description	Qty.
M58X Unit		4
KIT00188		4
KIT00189		1
KIT00174		1

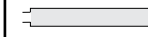



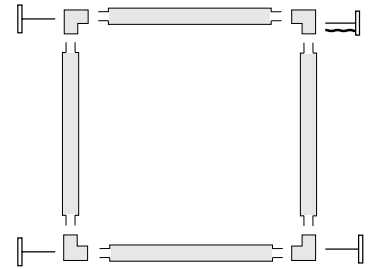

### Square / Rectangle

Part #	Description	Qty.
M57 Unit		4
KIT00188		3
KIT00189		1
KIT00172		4

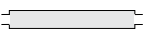

### Row with flat ends

Part #	Description	Qty.
M56X Unit		1
M57 Unit		2
M58X Unit		1
KIT00188		4
KIT00189		1
KIT00171		3

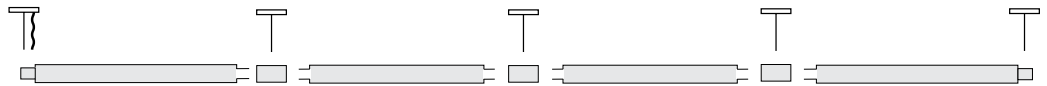

# ALLURA A EXTENDED

LED Linear Pendant A

LED

ARCHITECTURAL LIGHTING



VISIONEERING

by VISCOR

Project:	Catalogue #:	Type:
Notes:		

## Mounting Points

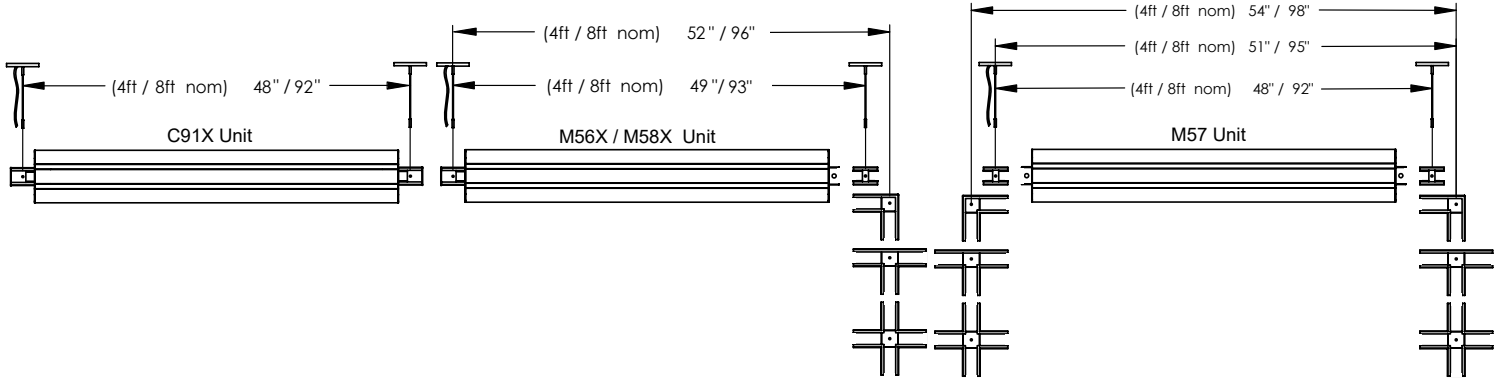

## Photometrics

IES File: **ALRA48-LED840K60LUNV**  
 Lumens: **5928**  
 Wattage: **47**  
 Efficacy: **126**

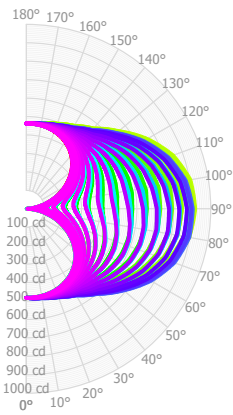

### Zonal Lumen Summary

Zone	Lumens	%Fixture
0.0° - 30.0°	412	7.0%
0.0° - 40.0°	723	12.2%
0.0° - 60.0°	1558	26.3%
0.0° - 90.0°	3031	51.1%
0.0° - 110.0°	3985	67.2%
0.0° - 130.0°	4873	82.2%
0.0° - 150.0°	5534	93.4%
0.0° - 170.0°	5883	99.2%
0.0° - 180.0°	5928	100.0%

### Coefficients of Utilization

pc	80%			70%			50%		
	70%	50%	30%	70%	50%	30%	70%	50%	30%
0	107	107	107	99	99	99	84	84	84
1	94	88	82	86	81	76	72	68	64
2	84	75	67	77	68	62	63	57	52
3	76	64	55	69	59	51	57	49	43
4	69	56	47	63	52	43	51	43	36
5	63	49	40	57	45	37	47	38	31
6	58	44	35	52	40	32	43	34	27
7	53	39	31	48	36	28	40	30	24
8	49	36	27	45	33	25	37	28	21
9	46	32	24	42	30	22	34	25	19
10	42	30	22	39	27	20	32	23	17

### Average Luminance Table (cd/m<sup>2</sup>)

	0.00°	45.00°	90.00°
0.00°	2557	2557	2557
45.00°	2742	3276	4130
55.00°	2726	3796	5470
65.00°	2627	4610	7609
75.00°	2390	6157	11347
85.00°	1479	10408	20033

Effective Floor Cavity Reflectance: 20%

