



VISCOR INC

Viscor Inc
35 Oak Street
Toronto, ON Canada M9N 1A1
www.viscor.com
Tel: 416.245.7991
Fax: 416.245.4778

Title: **KIT00046**

ERP# IIS00136

Date: MAY 2015

WARNINGS

Electric shock:

- Disconnect or turn off power before installing or servicing luminaire.
- All electrical wiring to be completed by a qualified licensed electrician in accordance with local and National/Canadian Electrical Code.
- Ensure supply voltage corresponds with the correct ballast/driver voltage.
- Avoid exposing wiring to metal edges and sharp objects.
- Ensure that the luminaire is properly grounded to prevent electric hazards.

Fire:

- Keep flammable and combustible materials away from the light source and/or lens.
- Use correctly rated supply conductors as indicated by product labeling.

Burn:

- Allow luminaire to cool before handling luminaire.

Personal Injury:

- Wear safety glasses and gloves when handling the luminaire to avoid physical injury.
- Avoid direct eye contact with light source.
- Always support the weight of the luminaire.

KIT00044

MOUNTING AND SWIVEL CANOPY SET
FOR SLOPED CEILING (SET OF 2). M29

PENDANT LENGTH	KIT PART NUMBER
72"	KIT00046

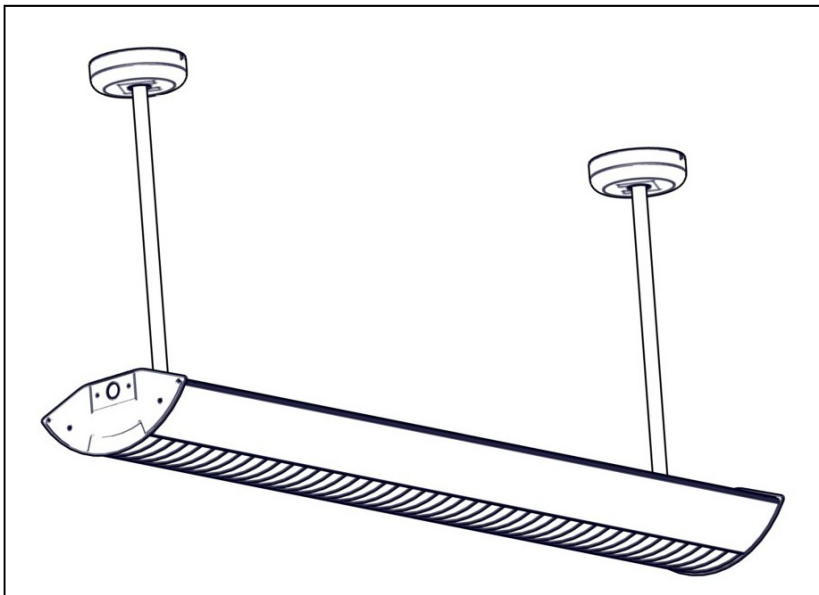
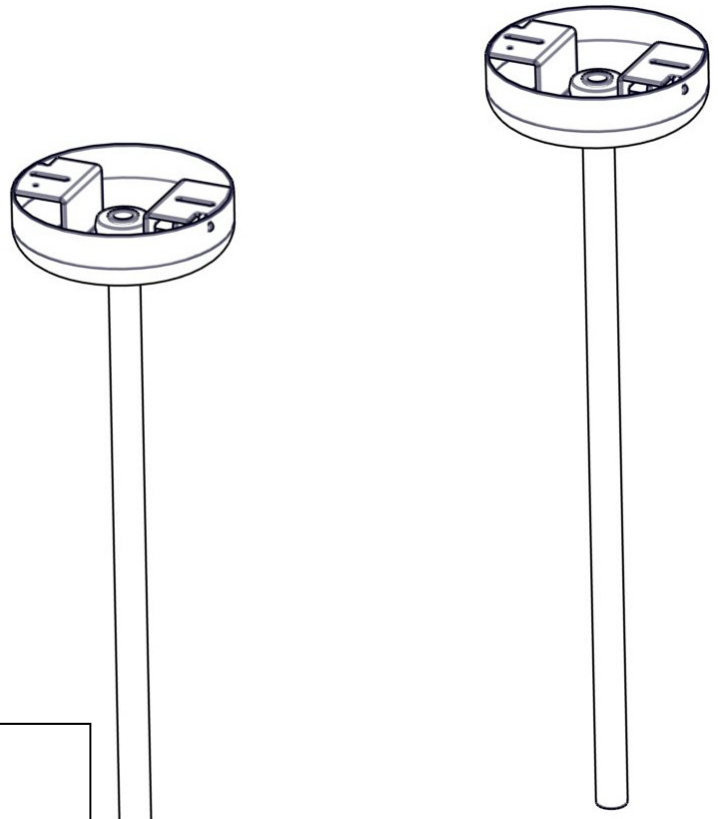

The Viscor Group

